

NOVA

**VARIAZIONI
SUL TEMA**
*VARIATIONS
ON A THEME*



LEA
CERAMICHE



UNA NUOVA SPERIMENTAZIONE SULLA MATERIA CERAMICA.

Leggeri movimenti e delicate venature resi mediante la sempre più affinata tecnica di stampa digitale, caratterizzano Nova, la nuova collezione di Lea Ceramiche. Prodotta in 3 formati con una varietà cromatica prevalentemente neutra, che la rende contemporanea e classica allo stesso tempo, si adatta a qualsiasi stile ed ambiente. Una naturale eleganza.

NEW EXPERIMENTS ON CERAMIC MATERIAL.

Subtle motion and delicate veins, created by means of the digital printing technique, characterise Nova, the new collection by Lea Ceramiche. Available in 3 sizes, with neutral colours that are both contemporary and classic, this collection is ideal for any environment. Natural elegance.



**NOVA
TAUPE SHINE**

Pavimento / Floor
grip rett. 60x60cm / 24"x24"





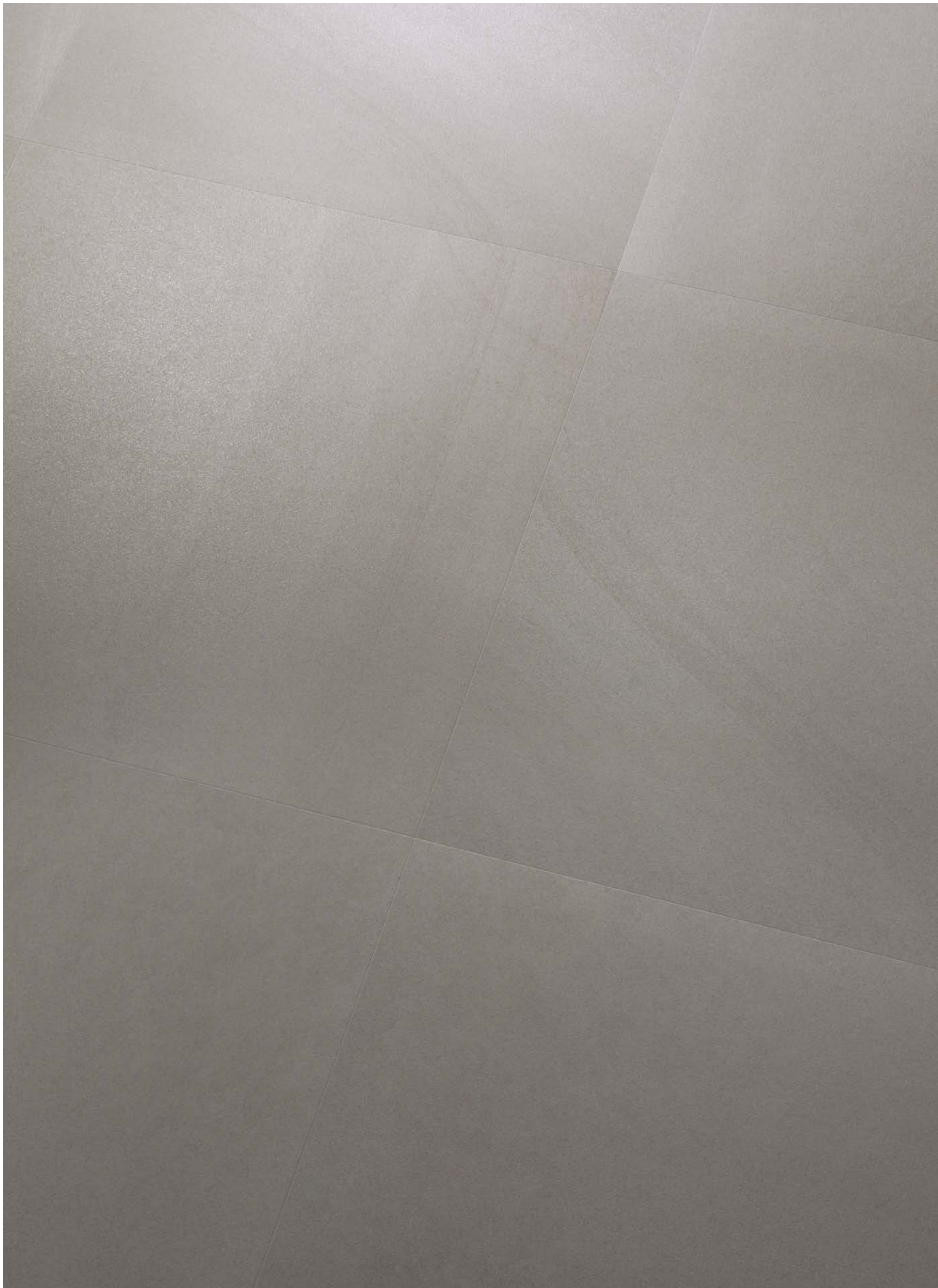



**NOVA
TAUPE SHINE**

Pavimento / Floor
grip rett. 60x60cm / 24"x24"





NOVA CINDER FLASH

Pavimento / Floor
nat. rett. 60x60cm / 24"x24"

**NOVA
SILVER RAY**

Pavimento / Floor
nat. rett. 60x120cm / 24"x48"

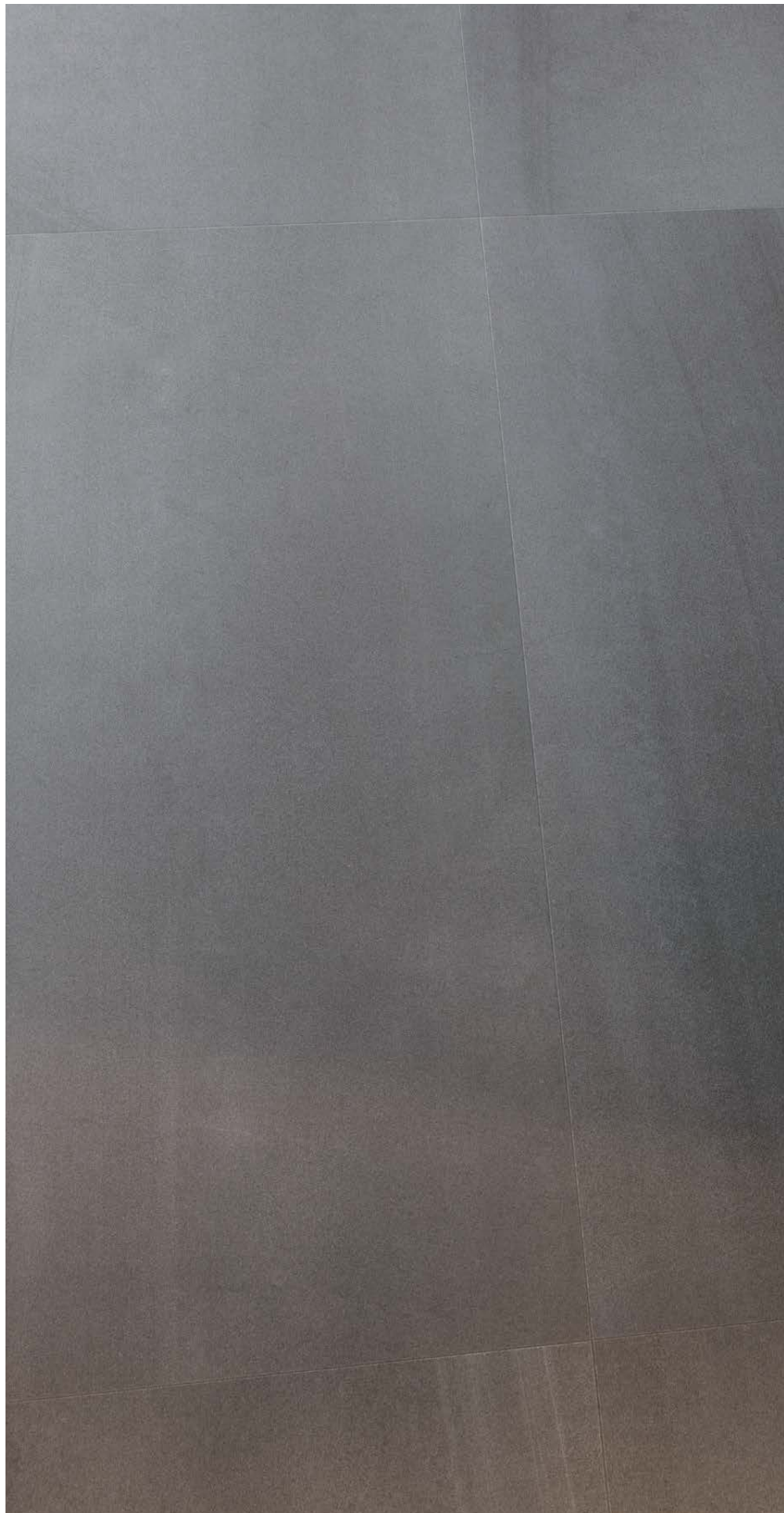



BAR



K
O
H
X



M



NOVA SILVER RAY

Parete / Wall

nat. rett. 30x60cm / 12"x24"

Pavimento / Floor

nat. rett. 60x120cm / 24"x48"

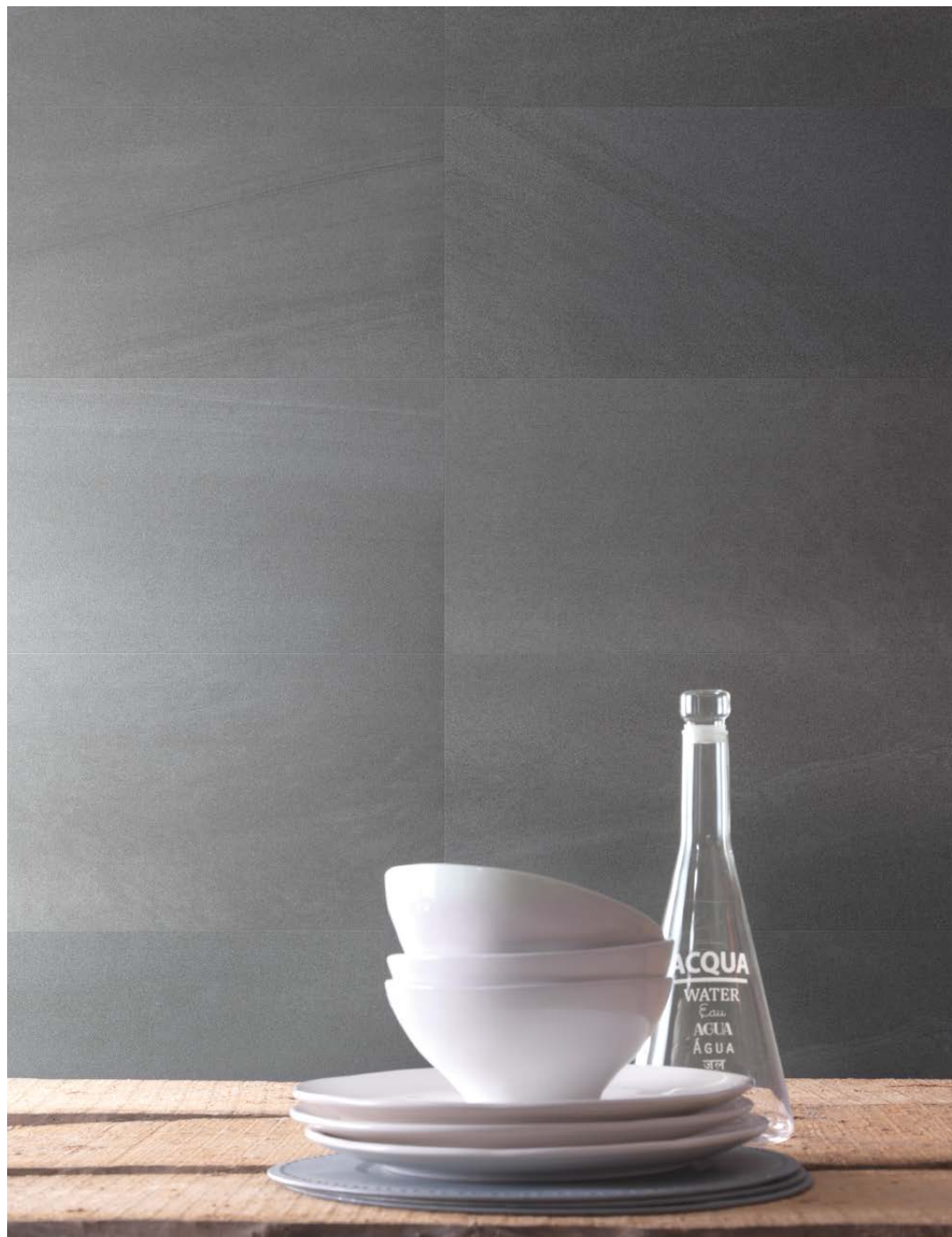

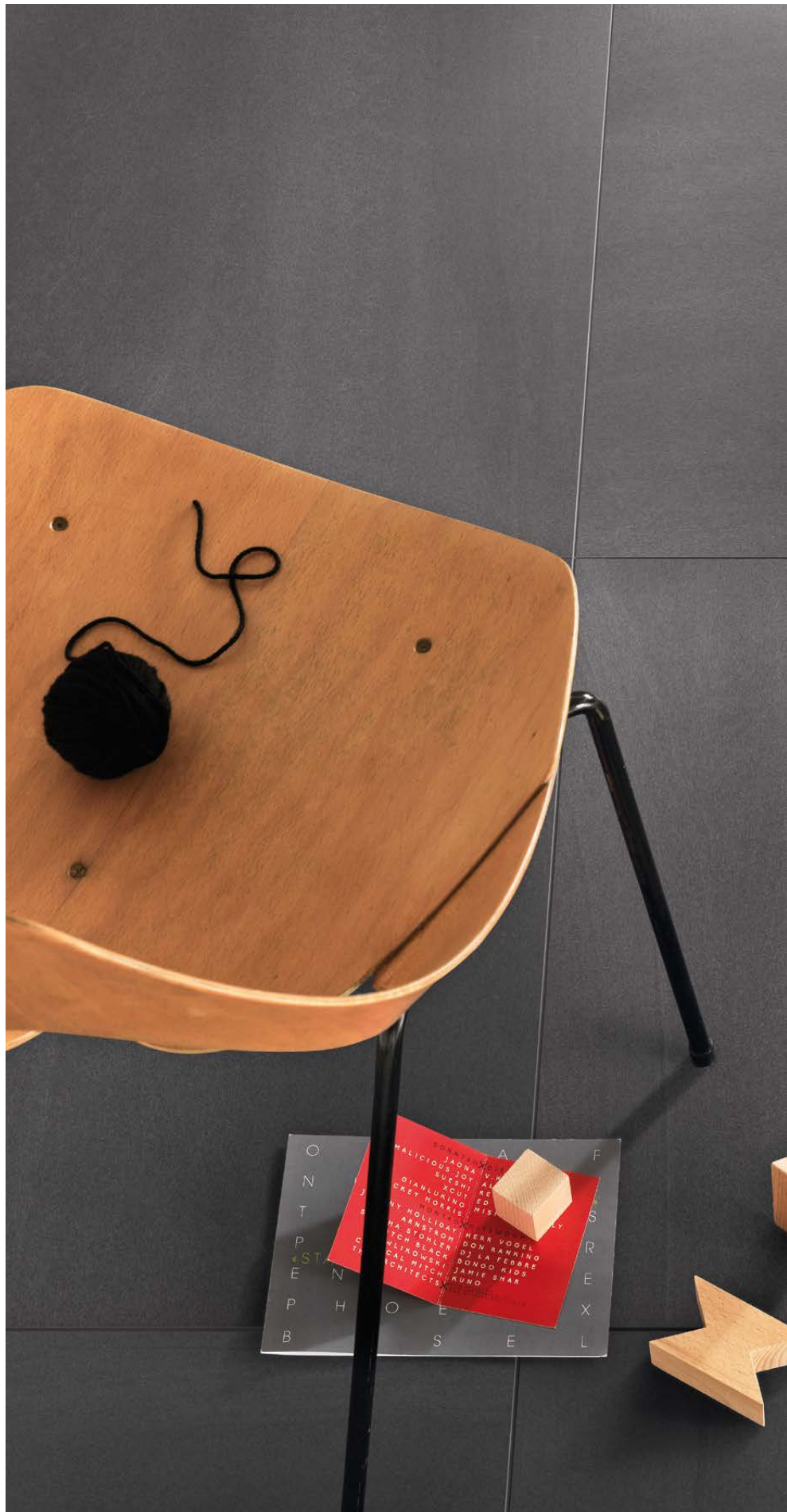

**NOVA
GREY BURST**

Pavimento / Floor
nat. rett. 60x60cm / 24"x24"

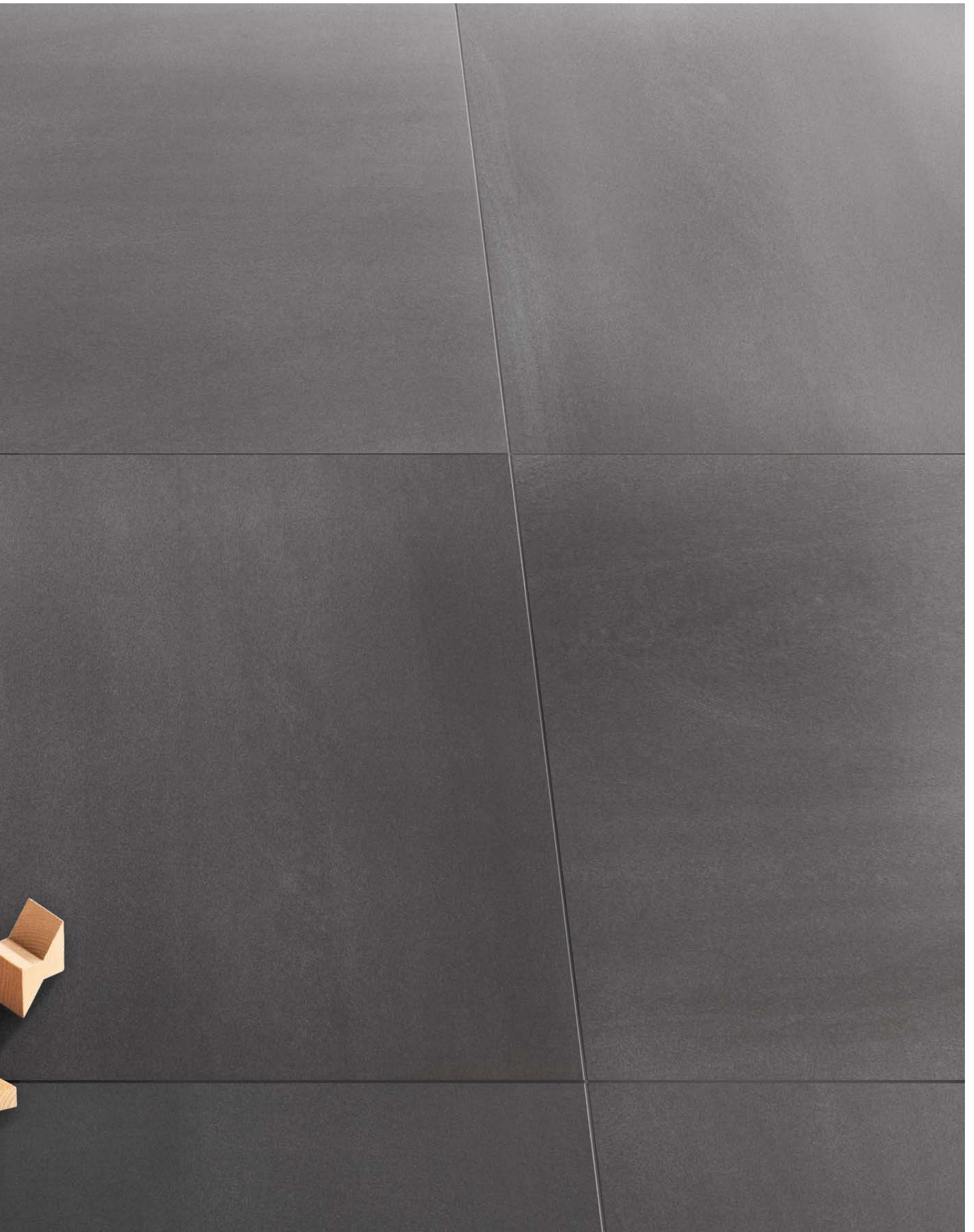



**NOVA
TAUPE SHINE**

Pavimento / Floor
nat. rett. 60x60cm / 24"x24"



FORMATI E COLORI

SIZES AND COLORS_FORMATS ET COULEURS_FORMATE UND FARBEN

TAUPE SHINE



30x60cm / 12"x24"
nat. rett.
*grip rett.

LGWNO20
LGWNO25

CINDER FLASH



30x60cm / 12"x24"
nat. rett.
*grip rett.

LGWNO30
LGWNO35



60x60cm / 24"x24"
nat. rett.
*grip rett.

LGWNO20
LGWNOG2



60x60cm / 24"x24"
nat. rett.
*grip rett.

LGWNO30
LGWNOG3



60x120cm / 24"x48"
nat. rett.

LGXNO21



60x120cm / 24"x48"
nat. rett.

LGXNO31

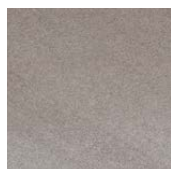

30x30cm / 12"x12"
**nat. rett. LGCNO20



15x15cm / 6"x6"
**nat. rett. LGINO20



30x30cm / 12"x12"
**nat. rett. LGCNO30



15x15cm / 6"x6"
**nat. rett. LGINO30

*non trattato con antibatterico
without antimicrobial treatment
sans traitement antibacterien
nicht mit antibakterieller
Wirkung ausgestattet

SILVER RAY

GREY BURST



30x60cm / 12"x24"
nat. rett. LGWNO10
*grip rett. LGWNO15



30x60cm / 12"x24"
nat. rett. LGWNO00
*grip rett. LGWNO05

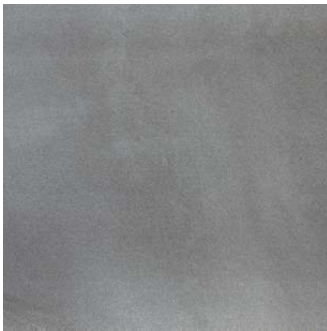

60x60cm / 24"x24"
nat. rett. LGWNO10
*grip rett. LGWNOG1

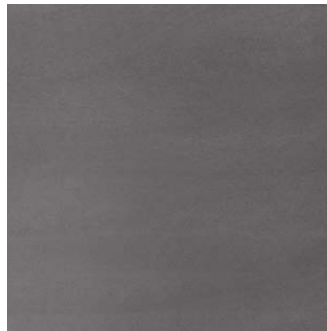

60x60cm / 24"x24"
nat. rett. LGWNO00
*grip rett. LGWNOG0



60x120cm / 24"x48"
nat. rett. LGXNO11



60x120cm / 24"x48"
nat. rett. LGXNO01



30x30cm / 12"x12"
**nat. rett. LGCNO10



15x15cm / 6"x6"
**nat. rett. LGINO10



30x30cm / 12"x12"
**nat. rett. LGCNO00



15x15cm / 6"x6"
**nat. rett. LGINO00

**Su richiesta. Per maggiori informazioni circa quantità minime e tempi di consegna rivolgersi all'ufficio commerciale.
Upon request. For more information about minimum quantities and delivery times please contact the sales department.
Sur demande. Pour plus d'informations sur les quantités minimales et délais de livraison s'il vous plaît contacter le département des ventes.
Auf Anfrage. Für weitere Infos über die Mindestmengen und Lieferzeiten wenden Sie sich bitte an unserer Verkaufsabteilung.

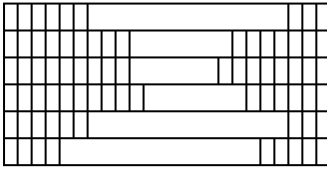

MOSAICO GRAVITY

30x60cm / 12"x24"

grey burst

silver ray

taupe shine

cinder flash

LGVNO50

LGVNO51

LGVNO52

LGVNO53

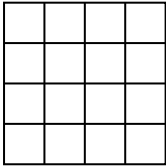

MOSAICO 3D

28x28cm / 11"x11"

grey burst

silver ray

taupe shine

cinder flash

LGPN000

LGPN010

LGPN020

LGPN030

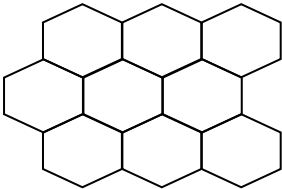

MOSAICO ANDROMEDA

20x30cm / 8"x12"

grey burst

silver ray

taupe shine

cinder flash

LGHNO00

LGHNO10

LGHNO20

LGHNO30

BACCHETTA BLUE RAY

1,2x60cm / 1/2"x24"

LG9NO50

BACCHETTA GOLD RAY

1,2x60cm / 1/2"x24"

LG9NO51



**NOVA
SILVER RAY**

Parete / Wall
nat. rett. 60x60cm / 24"x24"

NATURALE

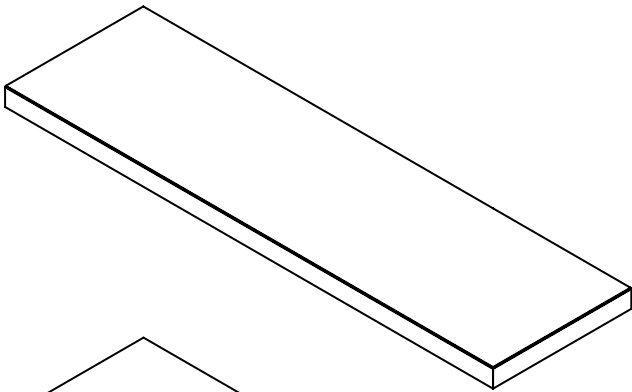

ANGOLO SX GRADINO PLUS nat. rett.
 35x120cm / 13^{3/4}"x48"
 grey burst
 silver ray
 taupe shine
 cinder flash

LG9NOS0
 LG9NOS1
 LG9NOS2
 LG9NOS3

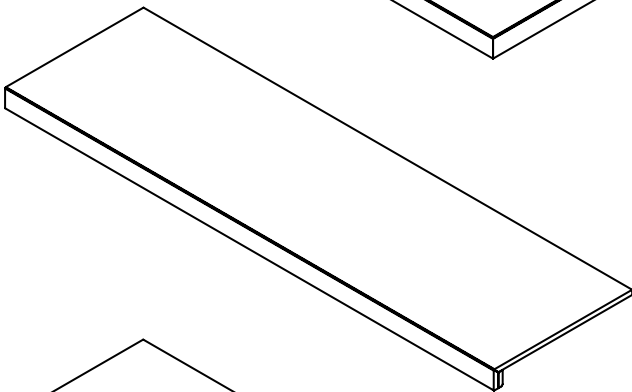

GRADINO PLUS nat. rett.
 35x120cm / 13^{3/4}"x48"
 grey burst
 silver ray
 taupe shine
 cinder flash

LG9NOP0
 LG9NOP1
 LG9NOP2
 LG9NOP3

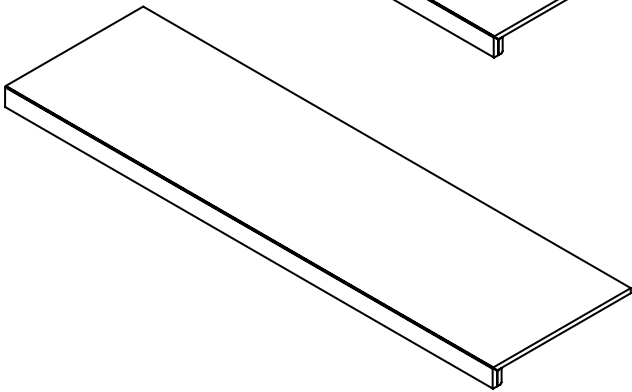

ANGOLO DX GRADINO PLUS nat. rett.
 35x120cm / 13^{3/4}"x48"
 grey burst
 silver ray
 taupe shine
 cinder flash

LG9NOD0
 LG9NOD1
 LG9NOD2
 LG9NOD3

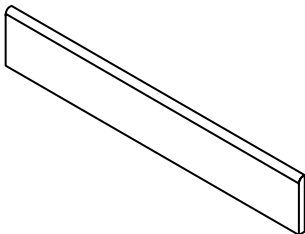

BATTISCOPA nat. rett.
 10x60cm / 4"x24"
 grey burst
 silver ray
 taupe shine
 cinder flash

LGBNO00
 LGBNO10
 LGBNO20
 LGBNO30

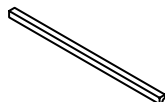

RACCORDO JOLLY nat.
 1,3x30cm / 1/2"x12"
 grey burst
 silver ray
 taupe shine
 cinder flash

LG9NOR0
 LG9NOR1
 LG9NOR2
 LG9NOR3



BEAK JOLLY nat.
 1,3x2cm / 1/2"x3/4"
 grey burst
 silver ray
 taupe shine
 cinder flash

LG9NOJ0
 LG9NOJ1
 LG9NOJ2
 LG9NOJ3

GRIP*

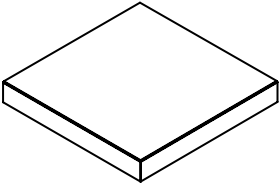

ANGOLO SX GRADINO PLUS grip*
 35x35cm / 13^{3/4}"x13^{3/4}"
 grey burst LG9NO0S
 silver ray LG9NO1S
 taupe shine LG9NO2S
 cinder flash LG9NO3S

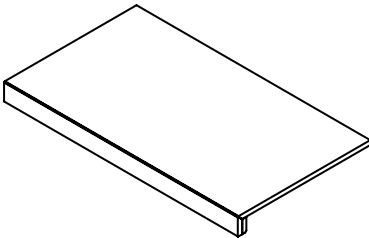

GRADINO PLUS grip rett.*
 35x60cm / 13^{3/4}"x24"
 grey burst LG9NO00
 silver ray LG9NO10
 taupe shine LG9NO20
 cinder flash LG9NO30

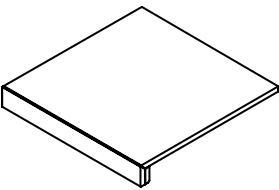

ANGOLO DX GRADINO PLUS grip*
 35x35cm / 13^{3/4}"x13^{3/4}"
 grey burst LG9NO0D
 silver ray LG9NO1D
 taupe shine LG9NO2D
 cinder flash LG9NO3D

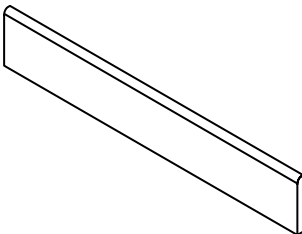

BATTISCOPA grip rett.*
 10x60cm / 4"x24"
 grey burst LGBNO05
 silver ray LGBNO15
 taupe shine LGBNO25
 cinder flash LGBNO35

*non trattato con antibatterico
 without antimicrobial treatment
 sans traitement antibacterien
 nicht mit antibakterieller
 Wirkung ausgestattet

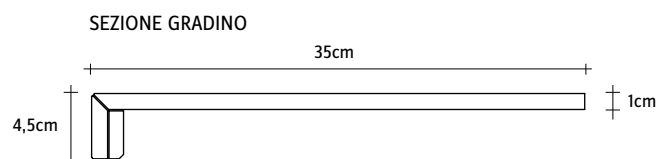

CARATTERISTICHE TECNICHE

TECHNICAL CHARACTERISTICS_CARACTÉRISTIQUES TECHNIQUES_TECHNISCHE EIGENSCHAFTEN













NOVA

gres tutta massa UGL

full-body porcelain_grès cérame en pleine masse_vollgemischtes durchgefärbtes feisteinzeug

spessore 10mm

thickness_epaisseur_stärke

| | caratteristiche technical characteristics caractéristiques techniques technische eigenschaften | metodo di prova test method methode d'essai prüfmethode | fondi plain tile fond unfliese |
|---|---|--|---|
|  | assorbimento d'acqua water absorption absorption d'eau wasserabsorption | iso 10545-3 | E ≤ 0,04% |
|  | resistenza al gelo frost resistance résistance au gel frostbeständigkeit | iso 10545-12 | resistente resistant résistant beständig |
|  | resistenza alla flessione bending strength résistance à la flexion beigefestigkeit | iso 10545-4 | ≥ 50 N/mm ² |
|  | sforzo di rottura (S) breaking strength (S) chargement de rupture (S) bruchlast (S) | iso 10545-4 | ≥ 2500 N |
|  | resistenza all'abrasione profonda résistance to deep abrasion résistance à l'abrasion profonde widerstand gegen tiefenabrieb | iso 10545-6 | ≤ 145 mm ³ |
|  | dilatazione termica lineare thermal expansion dilatation thermique linéaire thermische dilatation | iso 10545-8 | $\alpha \leq 7 \times 10^{-6} \text{ } ^\circ\text{C}^{-1}$ |
|  | resistenza agli sbalzi termici thermal shock resistance résistance aux chocs thermiques temperatur wechselbeständigkeit | iso 10545-9 | resistente resistant résistant beständig |
|  | resistenza attacco chimico chemical resistance résistance chimique chemischee beständigkeit | iso 10545-13 | uha, ula resistente resistant résistant beständig |
|  | resistenza alle macchie stain resistance résistance aux taches fleckenbeständigkeit | iso 10545-14 | 5 resistente resistant résistant beständig |
|  | resistenza allo scivolamento slip resistance résistance au glissement rutschfestigkeit | din 51130 | r10(nat.) r11(grip) |
|  | resistenza allo scivolamento slip resistance résistance au glissement rutschfestigkeit | din 51097 | B (A+B) (nat.) C (A+B+C) (grip) |
|  | coefficiente di attrito dinamico dynamic friction coefficient coefficient de friction dynamique dynamischer reibungskoeffizient | B.C.R. tortus | $\mu > 0,40$ |
|  | dynamic coefficient of friction (DCOF) | ANSI A 137.1:2012 (BOT 3000) | DCOF ≥ 0.42 |
|  | wet pendulum test | AS 4586:2013 | class P3(X) (grip) |
|  | stonalizzazione shading denuançage spielfarbig | | V2 |

**impieghi
uses
emploi
anwendungsbereiche**

| | | | |
|---|--|---|--|
|  | alberghi hotels hotels hotels |  | locali pubblici public spaces lieux publics öffentliche bereiche |
|  | abitazioni housing maisons wohnbereiche |  | aeroporti airports aéroports flughafen |
|  | bar - ristoranti bar - restaurants bar - restaurants cafés - restaurants, gasthäuser |  | centri commerciali malls centre commerciaux einkaufszentren |
|  | negozi shops magasins geschäfte |  | stazioni train stations gares bahnhofe |

**imballaggi
packing
emballage
verpackungen**

| articolo | scatola | | | europallet | | | | |
|------------------------------|---------|---|----|------------|------|----|-----------|--------|
| | pz. | mq | kg | scat. | mq | kg | | |
| fondo | 60x120 | 24"x48" | 2 | 1,44 | 35,5 | 24 | 34,6 | 852,0 |
| fondo | 60x60 | 48"x48" | 4 | 1,44 | 35,5 | 32 | 46,1 | 1024,0 |
| fondo | 30x60 | 12"x24" | 8 | 1,44 | 35,5 | 32 | 46,1 | 1136,0 |
| gradino plus nat. rett. | 35x120 | 13 ^{3/4} "x48" | 2 | 0,84 | 23,2 | 24 | 20,2 | 556,8 |
| gradino plus grip | 35x35 | 13 ^{3/4} "x13 ^{3/4} " | 4 | 0,84 | 21,2 | 16 | 13,5 | 339,2 |
| ang. gradino plus nat. rett. | 35x120 | 13 ^{3/4} "x48" | 1 | 0,42 | 12,4 | 24 | 10,1 | 297,6 |
| ang. gradino plus grip | 35x35 | 13 ^{3/4} "x13 ^{3/4} " | 4 | 0,49 | 13,4 | 30 | 14,7 | 402,0 |
| battiscopa nat. rett. / grip | 10x60 | 4"x24" | 12 | 7,2 m.l. | 16,0 | 60 | 43,2 m.l. | 960,0 |
| raccordo jolly | 1,3x30 | 1/2"x12" | 16 | - | 1,3 | - | - | - |
| beak jolly | 1,3x2 | 1/2"x3/4" | 4 | - | 0,1 | - | - | - |

Le rappresentazioni fotografiche e descrittive dei prodotti di Lea Ceramiche riportate sui depliant, sui cataloghi e sugli altri materiali pubblicitari dell'azienda, sono puramente illustrative dello specifico prodotto rappresentato. Si precisa infatti che, successivamente alla pubblicazione dei materiali pubblicitari dell'azienda, il prodotto potrebbe subire leggere modifiche nel relativo processo produttivo, al fine di renderlo tecnologicamente migliore. Tali aggiustamenti tecnologici potrebbero determinare lievi differenze, anche estetiche e/o cromatiche, nel prodotto medesimo, con la conseguenza che lo stesso potrebbe risultare diverso da come rappresentato e/o illustrato e/o descritto nel materiale pubblicitario di Lea Ceramiche. Tali differenze non potranno essere in alcun modo considerate dall'acquirente un vizio e/o difetto del materiale ceramico stesso, bensì una caratteristica dello specifico prodotto. Tutti i materiali ceramici che imitano pietre naturali presentano differenze di colore e sfumature che non potranno in nessun modo essere considerate quale difetto del prodotto, ma bensì una qualità caratteristica di tali tipi di produzione.

The photographs and descriptions of Lea Ceramiche products given in the brochures, catalogues and other corporate advertising materials aim merely to represent the specific products. After the publication of the corporate advertising materials, the products may be slightly modified as a result of technological improvements. Such technological modifications may lead to slight differences in appearance and/or colour of the products, which may therefore differ from the representations, illustrations or descriptions given in the Lea Ceramiche advertising materials. Such differences shall in no way be deemed to be faults and/or defects in the ceramic materials, but rather intrinsic features of the specific products. All ceramic materials that imitate natural stone differ in color and nuances, and this cannot in any way be considered as a product defect, but rather a characteristic of these types of products.

CERTIFICAZIONI

CERTIFICATIONS_CERTIFICATIONS_PRÜFZEUGNISSE



iso 14001



iso 9001



emas

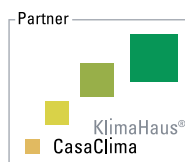

casaclima ***



leed*

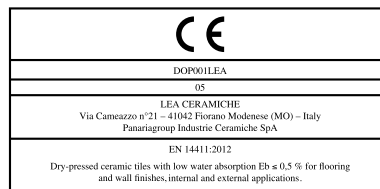

marchio CE



leed**

* LEED
Lea Ceramiche, tramite la holding Panariagroup Industrie Ceramiche S.p.A., è socio ordinario del Green Building Council e del GBC Italia. Through Panariagroup Industrie Ceramiche S.p.A., Lea Ceramiche is an ordinary member of the Green Building Council and the GBC Italia. Par le biais de Panariagroup Industrie Ceramiche S.p.A., Lea Ceramiche est membre ordinaire du Green Building Council et du GBC Italia. Lea Ceramiche, durch die Holding Panariagroup Industrie Ceramiche S.p.A., ist ordentliches Mitglied von dem Green Building Council und dem GBC Italien. Lea Ceramiche, a través del holding Panariagroup Industrie Ceramiche S.p.A., es miembro afiliado del Consejo Construcción Verde y del Consejo Construcción Verde de Italia.

** LEED
Il contenuto di materiale riciclato "pre-consumo" della serie Nova è del 40%, come certificato da ente esterno qualificato (certificato disponibile sul sito www.ceramichelea.com). Origini is produced with 40% of pre-consumer materials, as certified by a qualified external company (certificate available on the website www.ceramichelea.com).

*** CASACLIMA
Lea Ceramiche, tramite la holding Panariagroup Industrie Ceramiche S.p.A., ha ottenuto la certificazione Partner Casaclima. Through Panariagroup Industrie Ceramiche S.p.A., Lea Ceramiche has obtained the Partner Casaclima certification. Par le biais de Panariagroup Industrie Ceramiche S.p.A., Lea Ceramiche a obtenu la certification Partner Casaclima. Lea Ceramiche, durch die Holding Panariagroup Industrie Ceramiche S.p.A., hat die Bescheinigung als Partner Casaclima bekommen. Lea Ceramiche, a través del holding Panariagroup Industrie Ceramiche S.p.A., ha obtenido la certificación Partner Casaclima.



ADIMEMBER

TECNOLOGIA ANTIBATTERICA

ANTIMICROBIAL TECHNOLOGY_TECHNOLOGIE ANTIBACTÉRIENNE_ ANTIBAKTERIELLE TECHNOLOGIE



- Grazie alla tecnologia integrata a base di argento, le nostre piastrelle sono protette da un innovativo scudo antibatterico che elimina fino al 99,9% dei batteri dalla superficie e assicura una protezione inalterabile da usura, condizioni climatiche e ripetute pulizie in qualsiasi ambiente di utilizzo.

Thanks to built-in technology based on silver, our tiles are protected by an innovative antibacterial shield that eliminates up to 99.9% of bacteria on the surface of the tile and assures long-lasting protection against wear and tear, climatic conditions and repeated cleans in any usage environment.

- La protezione Microban® viene integrata direttamente nelle piastrelle durante il processo produttivo: quando i batteri entrano in contatto con la superficie trattata, la tecnologia Microban® agisce bloccandone il metabolismo. In questo modo si interrompe il ciclo vitale dei batteri che pertanto non sono più in grado di proliferare e sopravvivere.

The Microban® protection is incorporated into the tiles during the production process; once bacteria come into contact with the Microban® surface, the technology works by disrupting its biological functioning. The lifecycle cannot proceed and the bacteria then die.

- A differenza dei disinfettanti che rappresentano una soluzione istantanea, ma di breve durata, Microban® garantisce una protezione durevole, esercitando un'azione continua contro i batteri durante l'intero ciclo di vita del prodotto.

Disinfectants are an instant but short term solution that provide only a limited residual activity once the treated surface area dries and bacteria can very quickly start to grow and reproduce. As an alternative, Microban® technology guarantees long-lasting protection, continuously working to prevent the growth of bacteria throughout the entire life cycle of the product.

- La tecnologia Microban® funziona 24 ore su 24 garantendo di fatto una protezione continua giorno e notte, mantenendo le piastrelle più pulite fra una pulizia e l'altra.

Microban® technology is active 24 hours a day, guaranteeing continuous protection day and night, keeping the tiled surface more hygienic between cleanings.

NOVA

**VARIAZIONI
SUL TEMA**
*VARIATIONS
ON A THEME*



LEA

CERAMICHE

LEA CERAMICHE
Via Cameazzo, 21
41042 Fiorano Modenese
Modena Italy

Tel +39 0536 837811
Fax +39 0536 830326
info@ceramichelea.it
www.ceramichelea.com

Panariagroup Industrie Ceramiche
S.p.A.

SHOWROOM LEA CERAMICHE
Via Durini, 3
20122 Milano

Tel +39 02 76011406
showroom_milano@ceramichelea.it

LEA NORTH AMERICA, LLC
800 Clanton Road, Suite N
Charlotte, NC 28217

Tel +1 704 522 6300
Fax +1 704 522 6080
info@leausa.us
www.leausa.us